

SACAGAWEA

DESIGNS

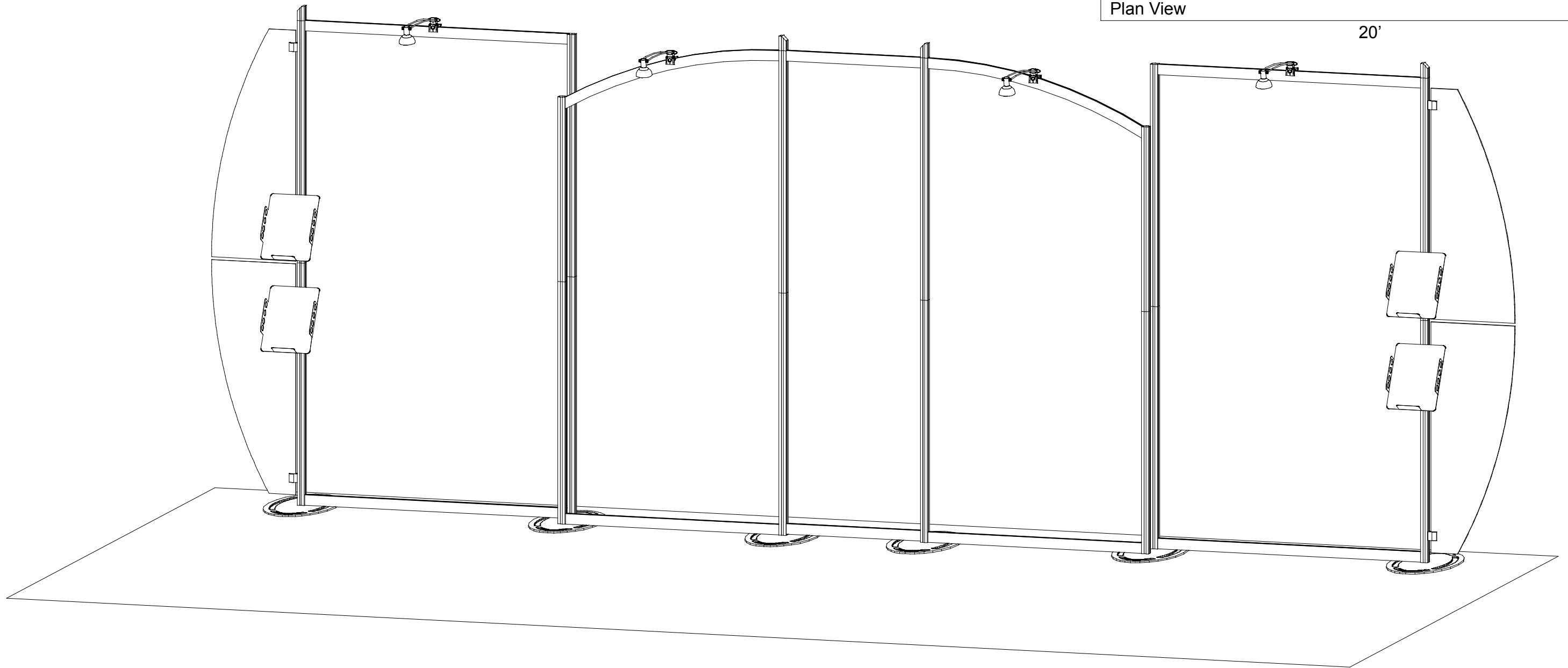
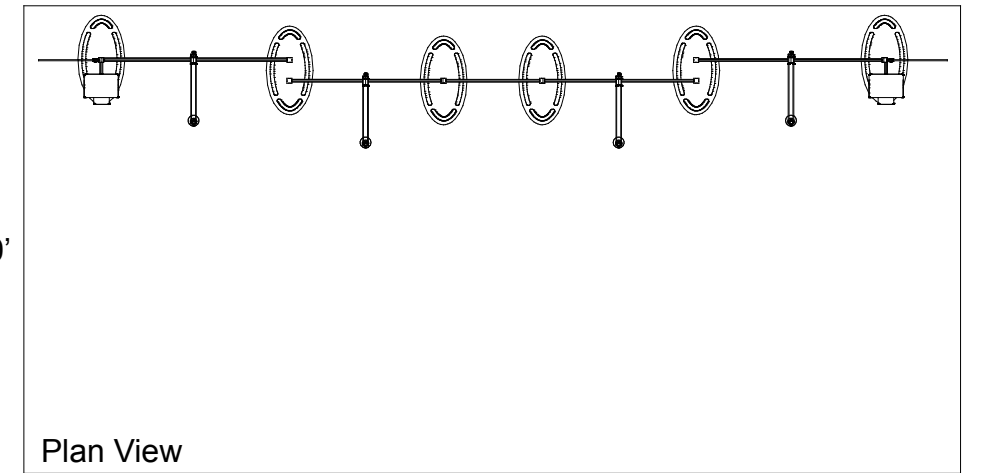

WHEN DISASSEMBLING ALUMINUM EXTRUSION, TIGHTEN ALL SETSCREWS AND LOCKS TO PREVENT LOSS DURING SHIPPING

SACAGAWEA DESIGNS

Using Your Set-up Instructions:

The Visionary Designs Set-up Instructions for Sacagawea displays are created specifically for your configuration. They are laid out sequentially, including an exploded view of the entire display and a logical series of detailed steps for assembly. We encourage you to study the instructions **before** attempting to assemble your exhibit.

THIS IS VERY IMPORTANT!

Each page reminds you to tighten the setscrews after disassembling your exhibit to prevent loss of the locks and setscrews (see below in red).

Cleaning & Packing Your Display:

- 1) Use care when cleaning aluminum extrusions or acrylic inserts. Use only non-abrasive cleaners.
- 2) When cleaning laminate inserts or counter tops, use mild cleansers and a soft material such as cotton.
- 3) Keep all display components away from extreme heat and long exposure to sunlight to avoid warping and fading.
- 4) Retain all packing materials. It will make re-packing much easier and will reduce the likelihood of shipping damage.

Hex Key Tool



Most visionary design exhibits can be assembled with the supplied Hex Key Tool. Occasionally, a flat head screwdriver may be required.

Typical Connection



Detail A: Most horizontal extrusion connections have a patented expandable lock. This lock inserts into the groove of an opposing extrusion. Tightening the lock with the Hex Key Tool expands the lock and creates a strong positive connection.

Typical Connection

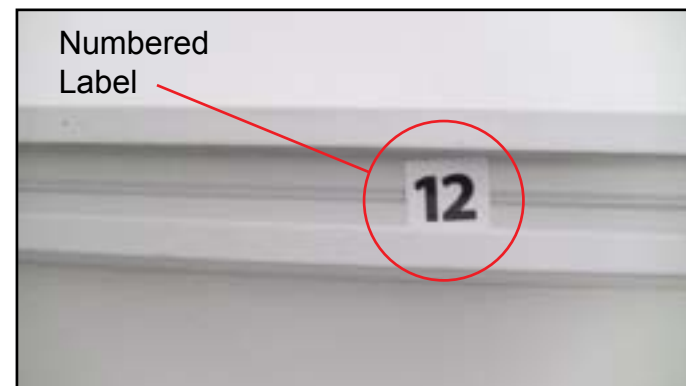

Detail B: Each extrusion contains a numbered label that corresponds to set-up instructions. The label is located within a groove of the extrusion (when possible). Visionary Design labels contain Black numbers unless otherwise specified.

Horizontal Connection



Detail C: A rectangular connection bar with plastic T Knobs is inserted between two horizontal extrusions joined end-to-end. Turn the knobs clockwise to tighten.

Do Not Overtighten.

Base Plate Connection



Detail D: Attach vertical extrusions to base plates with supplied bolts inserted through the hole in the plate. Be careful not to strip the thread.

Vertical Connection



Detail E: A square connection bar with plastic T Knobs is inserted between two vertical extrusions joined end-to-end. Turn the knobs clockwise to tighten.

Do Not Overtighten.

Corner Connection



Detail F: Plastic Star Knobs are used to tighten locks where horizontal extrusions connect with vertical extrusions. Turn the knobs clockwise to tighten. Turn counter-clockwise to loosen, but do not remove knob.

Do Not Overtighten.

WHEN DISASSEMBLING ALUMINUM EXTRUSION, TIGHTEN ALL SETSCREWS AND LOCKS TO PREVENT LOSS DURING SHIPPING

866.652.2100

Item	Qty.	Description
1	2	Base Plate w/ 1 Hole
1a	1	Base Plate w/ 2 Holes
2	1	42" Lower Vertical Extrusion
3	1	42" Upper Vertical Extrusion
4	1	42" Lower Vertical Extrusion
5	1	42" Upper Vertical Extrusion
6	1	42" Lower Vertical Extrusion
7	1	32" Upper Vertical Extrusion
8	1	42" Lower Vertical Extrusion
9	1	42" Upper Vertical Extrusion
10	2	47" Horizontal Extrusion
11	1	38.25" Horizontal Extrusion
12	1	40.9826" Curved Extrusion
14	1	4" Stabilizing Extrusion

Steps:

- 1) Attach vertical extrusions [2, 4, 6 and 8] to base plates [1 and 1a].
- 2) Attach upper vertical extrusions to lower extrusions using connection bar [b].
- 3) Attach horizontal extrusions [10, 11 and 12] between vertical assemblies as shown.
- 4) Apply graphic to back of assembled backwall.

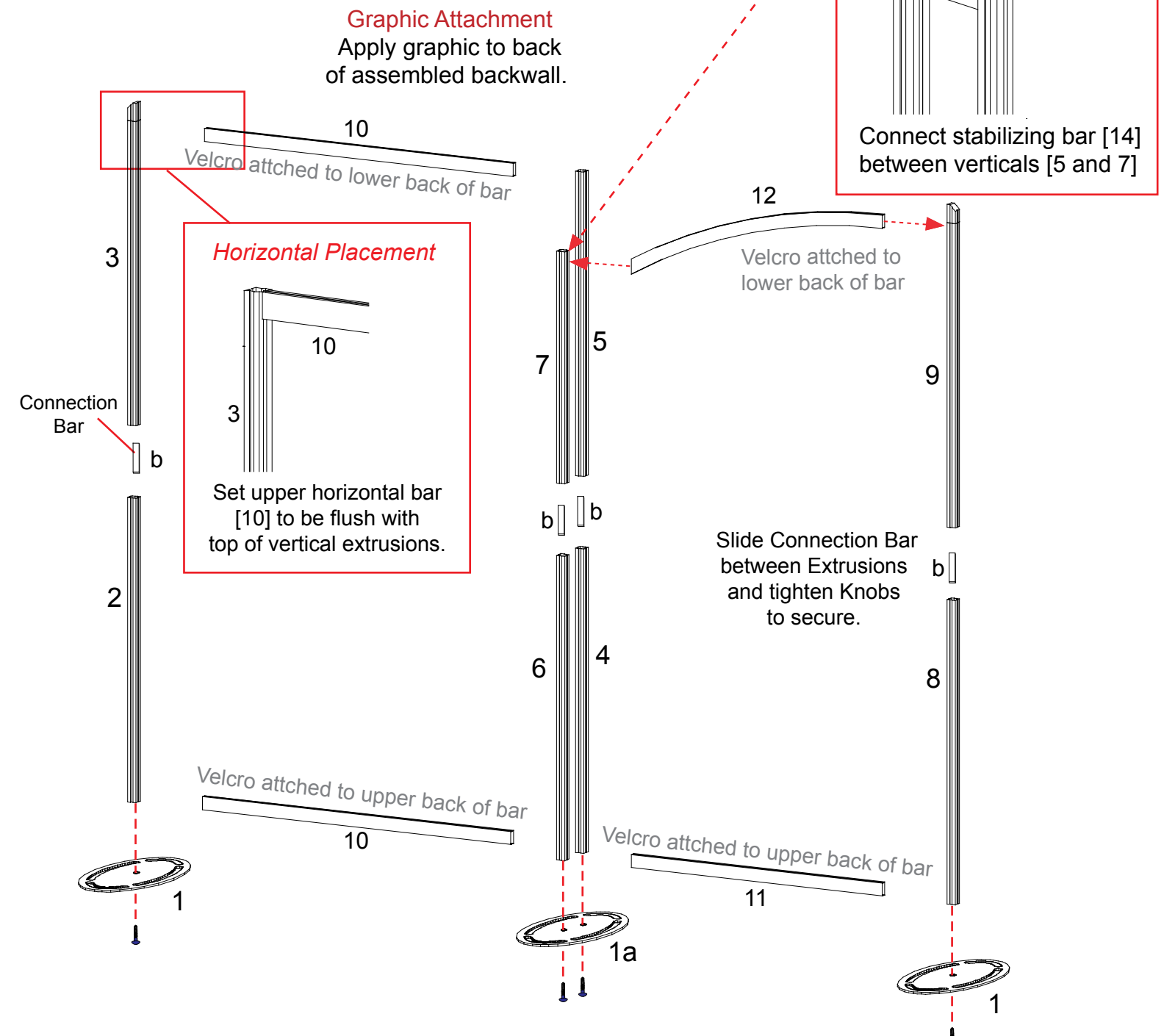
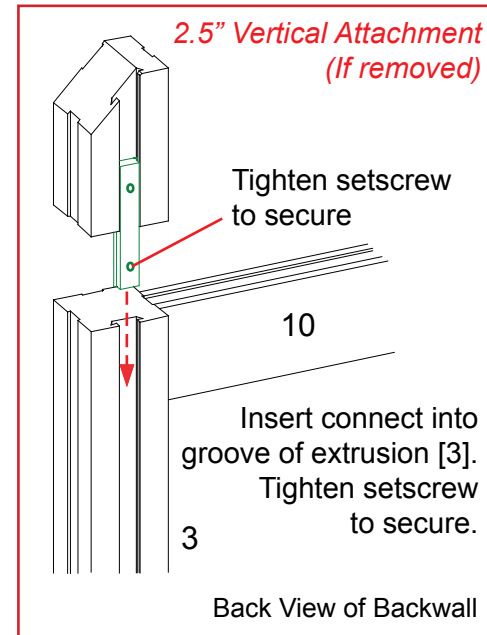

STAR indicates location of knobs on **BACKSIDE** of unit.

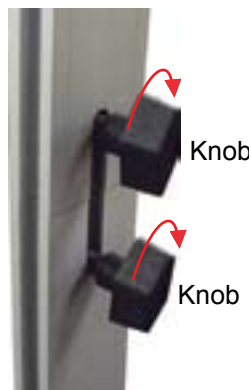

Turn Knob Clockwise to Tighten Lock

****Do not over tighten Knobs.****

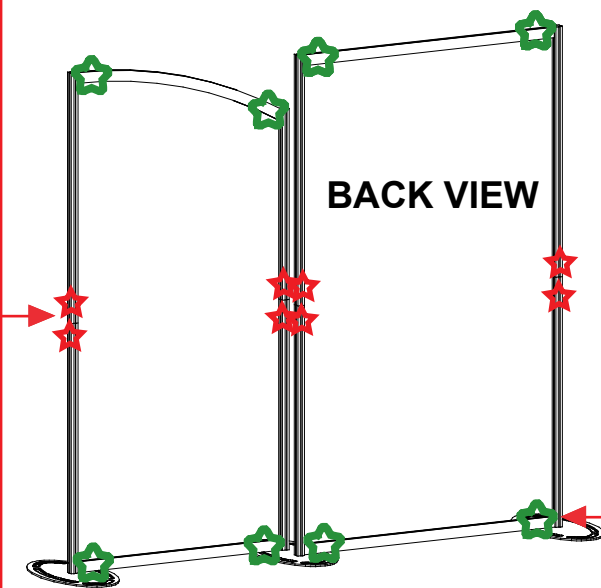

GREEN STAR indicates location of connection lock with knob.



WHEN DISASSEMBLING ALUMINUM EXTRUSION, TIGHTEN ALL SETSCREWS AND LOCKS TO PREVENT LOSS DURING SHIPPING

866.652.2100

Item	Qty.	Description
1	2	Base Plate w/ 1 Hole
1a	1	Base Plate w/ 2 Holes
2a	1	42" Lower Vertical Extrusion
3a	1	42" Upper Vertical Extrusion
4a	1	42" Lower Vertical Extrusion
5a	1	42" Upper Vertical Extrusion
6a	1	42" Lower Vertical Extrusion
7a	1	32" Upper Vertical Extrusion
8a	1	42" Lower Vertical Extrusion
9a	1	42" Upper Vertical Extrusion
10	2	47" Horizontal Extrusion
11	1	38.25" Horizontal Extrusion
12a	1	40.9826" Curved Extrusion
13	2	24" Horizontal Extrusion
14	1	4" Stabilizing Extrusion

Steps:

- 1) Attach vertical extrusions [2a, 4a, 6a and 8a] to base plates [1 and 1a].
- 2) Attach upper vertical extrusions to lower extrusions using connection bar [b].
- 3) Attach horizontal extrusions [10, 11 and 12a] between vertical assemblies as shown.
- 4) Attach horizontal extrusions [13] between vertical assemblies [8/9 & 8a/9a] as shown.
- 5) Apply graphic to back of assembled backwall.

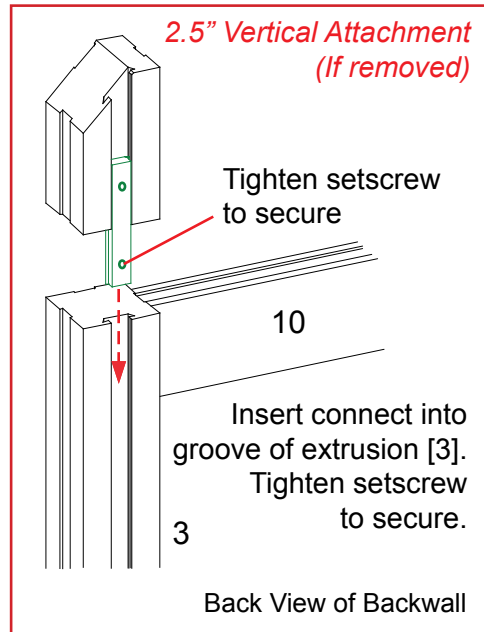

Graphic Attachment
Apply graphic to back of assembled backwall.

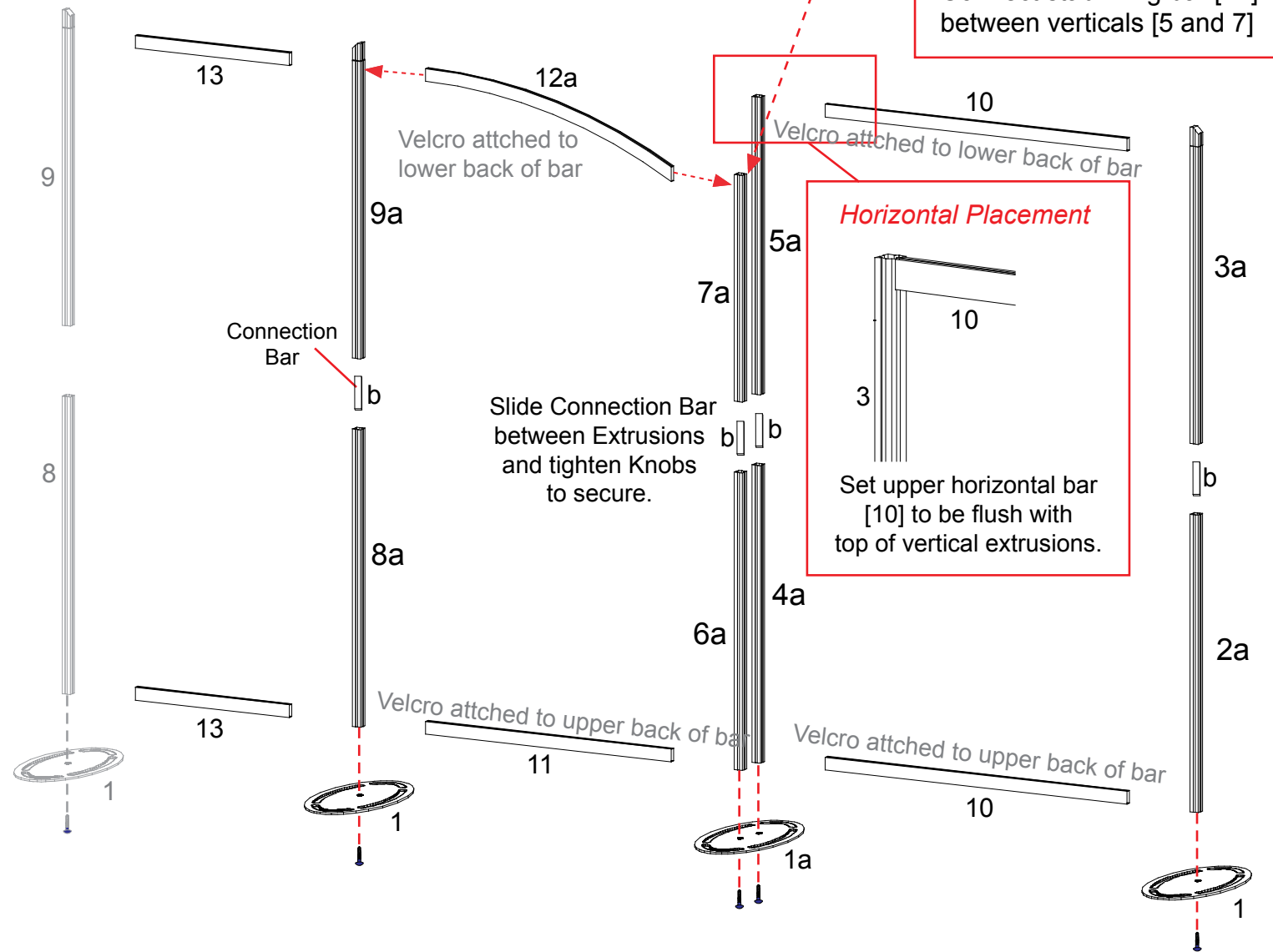

STAR indicates location of knobs on BACKSIDE of unit.

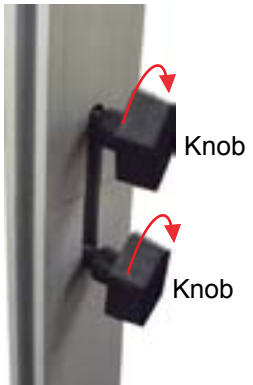

Turn Knob Clockwise to Tighten Lock

Do not over tighten Knobs.

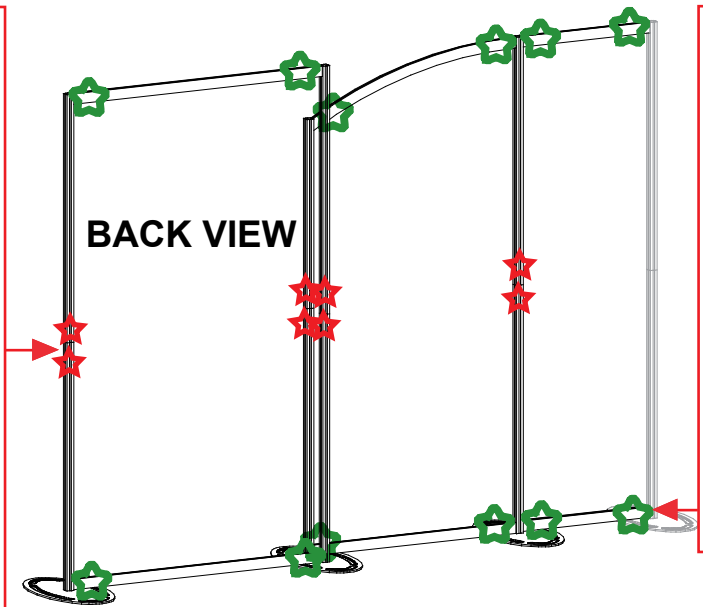

GREEN STAR indicates location of connection lock with knob.



WHEN DISASSEMBLING ALUMINUM EXTRUSION, TIGHTEN ALL SETSCREWS AND LOCKS TO PREVENT LOSS DURING SHIPPING

866.652.2100

Light Connection
 Attach Lights to Backwall where desired and tighten in place.

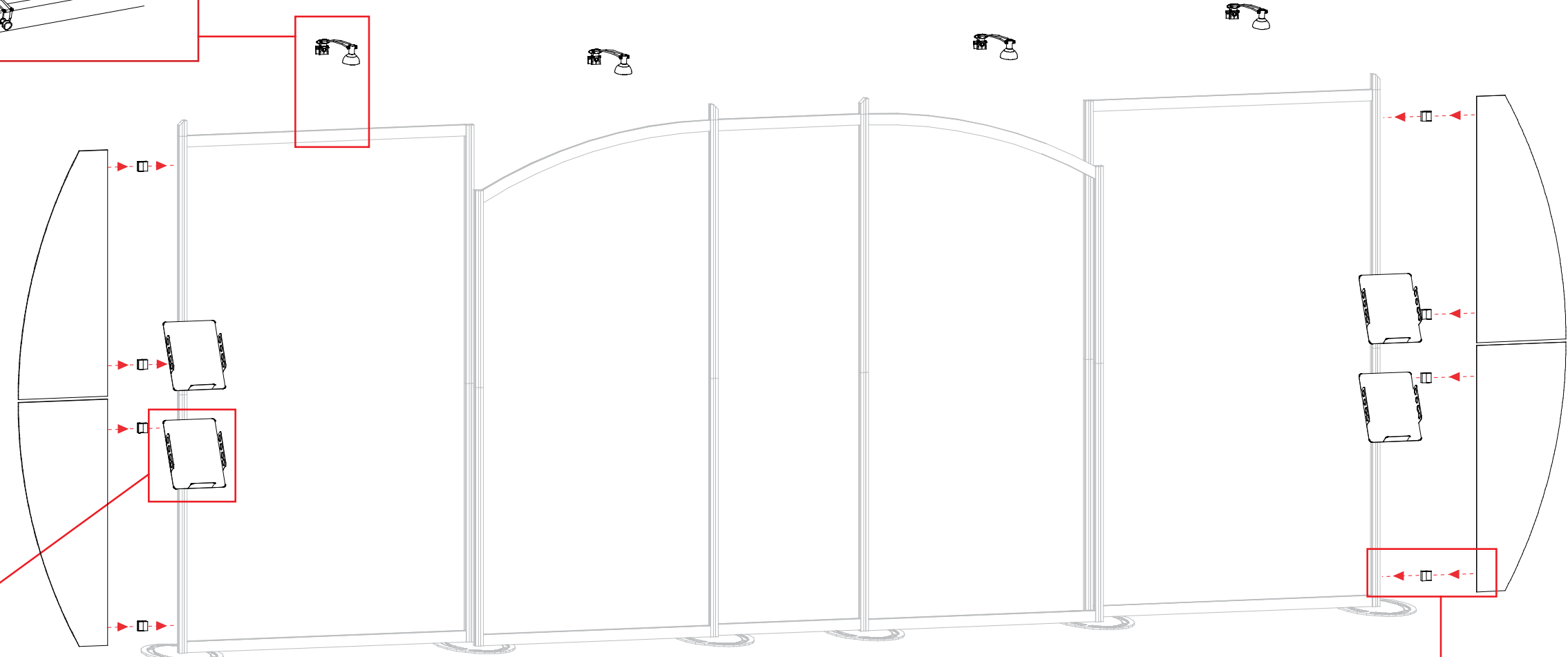

Literature Rack Attachment

Tighten Lock to Secure

Attach connector piece to rack as shown. Then connect assembled literature rack to vertical extrusion.

Example of A10 Clamp Attachment (If removed)

Slide connector on back of A10 clamp into groove of extrusion.

When desired location is found, tighten set screw to secure.

Tighten knob to secure wing in place.

WHEN DISASSEMBLING ALUMINUM EXTRUSION, TIGHTEN ALL SETSCREWS AND LOCKS TO PREVENT LOSS DURING SHIPPING

Top View of each Level

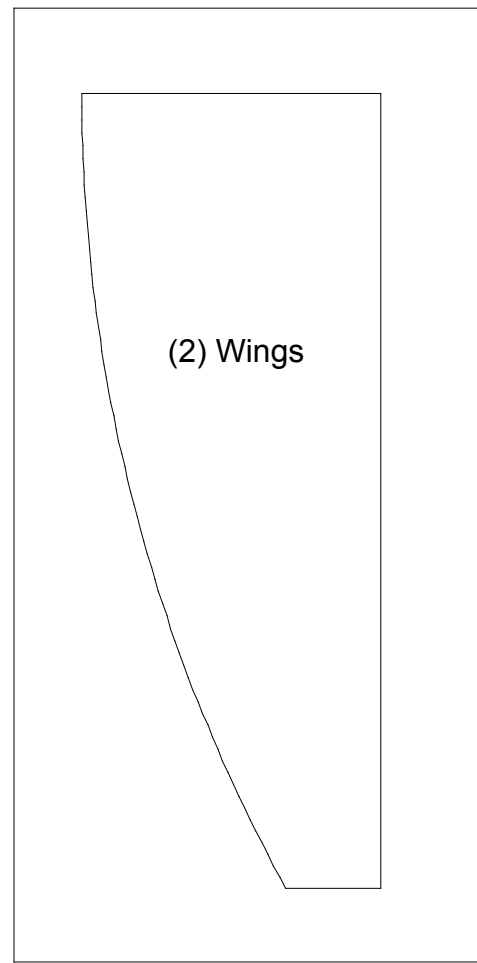

Level 1 [Bottom]

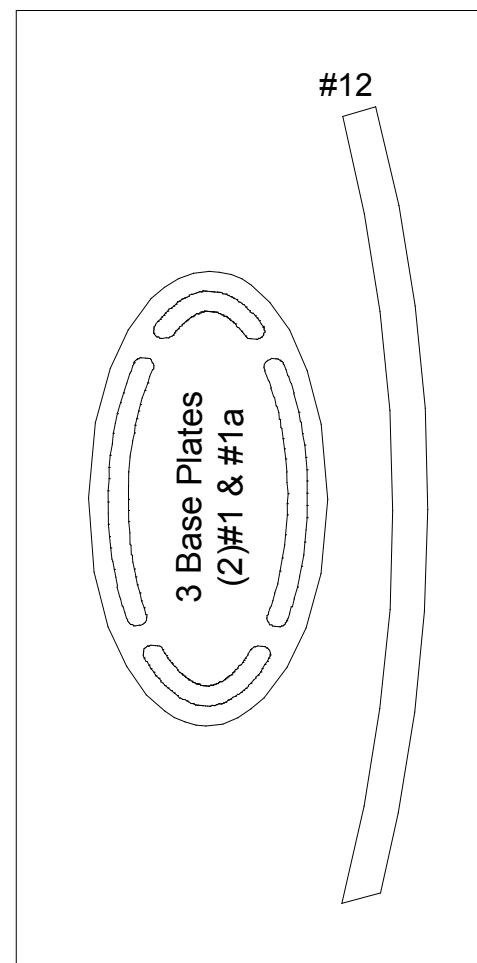

Level 2



Level 3

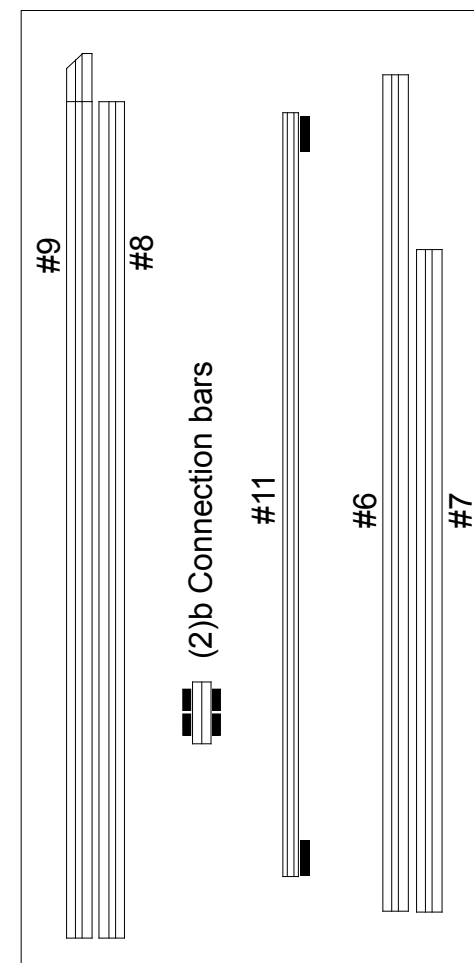

Level 4

Halogen Lights

Literature Pockets

Setup Hardware

WHEN DISASSEMBLING ALUMINUM EXTRUSION, TIGHTEN ALL SETSCREWS AND LOCKS TO PREVENT LOSS DURING SHIPPING

Top View of each Level

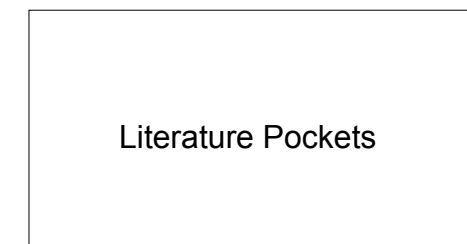
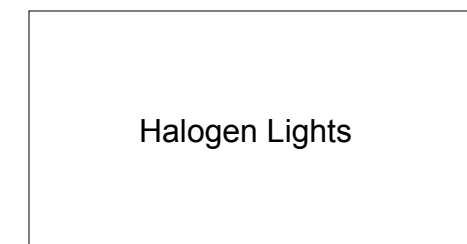
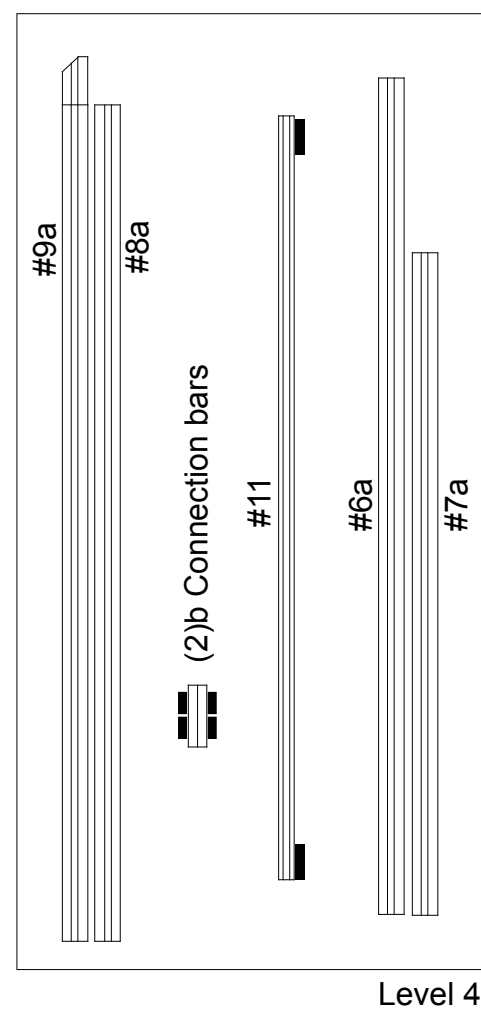
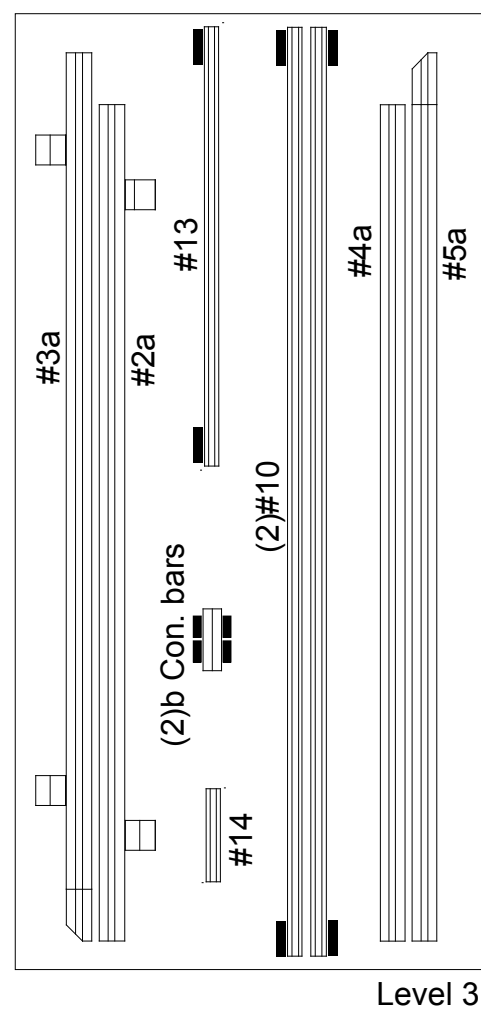
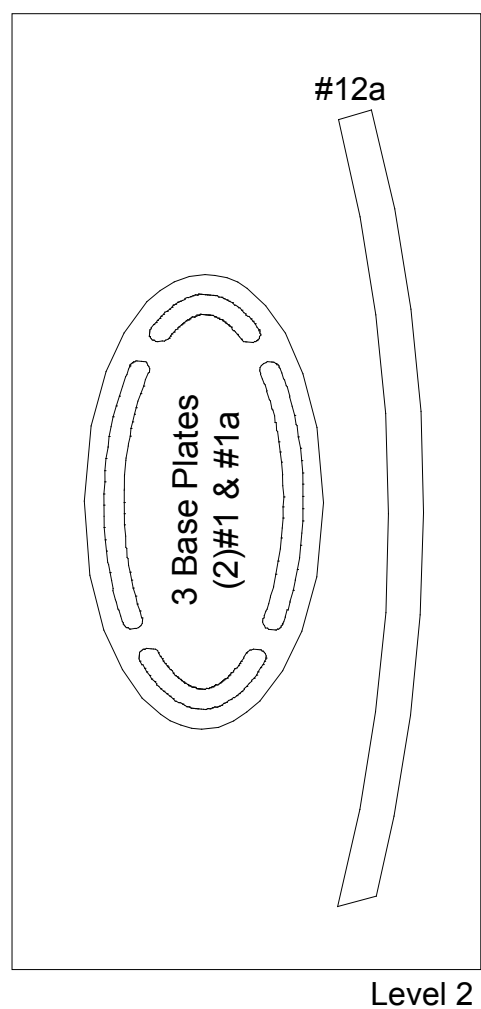
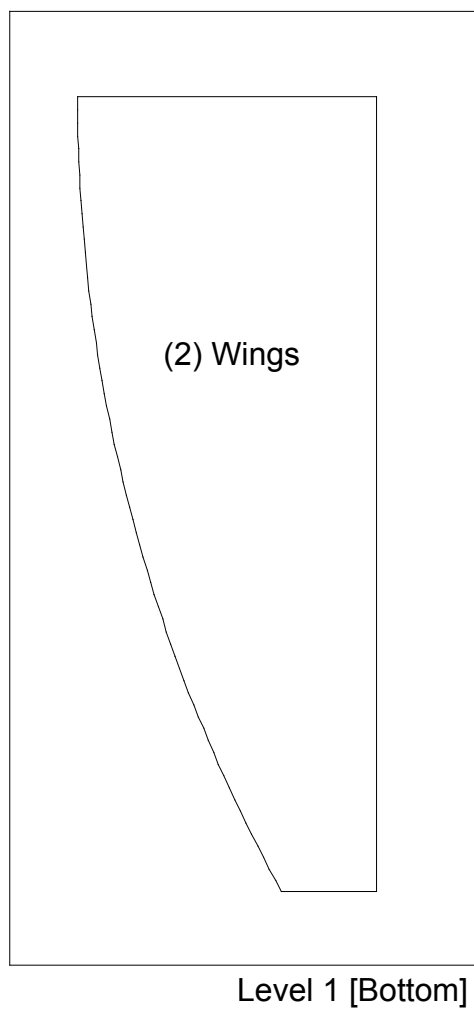

WHEN DISASSEMBLING ALUMINUM EXTRUSION, TIGHTEN ALL SETSCREWS AND LOCKS TO PREVENT LOSS DURING SHIPPING